

Produktbeskrivelse

Sikrede svingningsdæmpere er konstrueret med indbygget overbelastningssikring, som styrer udstyret under transport og giver en fuldstændig sikring under både stationære og mobile forhold.

En universel dæmper, som er populær til en lang række anvendelser. Effektive dæmpere til rimelige priser, som er nemme at montere. Gummiet belastes i tryk og forskydning og CML typens lille højde giver en rimelig reduktion af vibrationerne med en samlet lav byggehøjde.

Stålkappen beskytter imod vejr og UV stråling of afskærmer gummiet fra dryppende olie og brændstof.

Belastning fra 125 kg til 5000 kg

Anvendelse

Anvedelse

Dieselmotorer, generatorsæt, pumper, kompressorer, køretøjer, marinemotorer, mobile anlæg, entreprenørmaskiner og ventilatorer.



Type	A Ø (mm)	B (mm)	C	D1 (mm)	D2 (mm)	E (mm)	F (mm)	G (mm)
CML060	63	35	M10 - M12	76	90	110	9	2.5
CML080	77	30	M10 - M12	108	110	135	15	3
CML095	93	35	M10 - M12	122	124	144	10	2.5
CML110	106	38	M12 - M16	138	146	171	12.5	3
CML125	121	42	M12 - M16	156	158	190	13.5	3.3
CML150	155	48	M16	176	188	216	14	4
CML160	162	59	M20	-	140	170	14.5	4
CML180	180	66	M20	149	163	192	14.5	4
CML220	220	105	M24	-	180	220	17.5	6

CML060
CML080
CML095
CML110
CML125
CML150

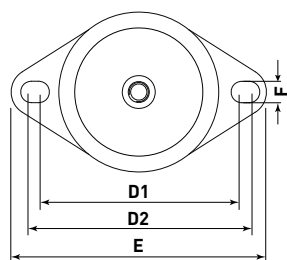

CML160
CML180
CML220

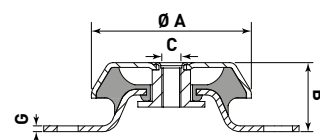
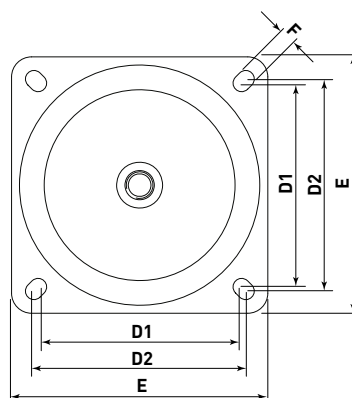

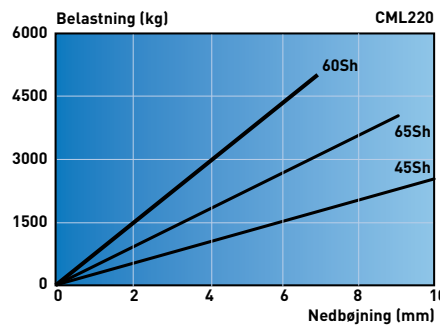
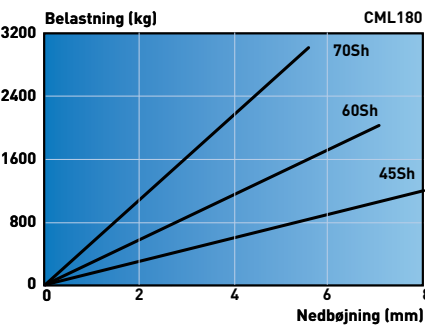
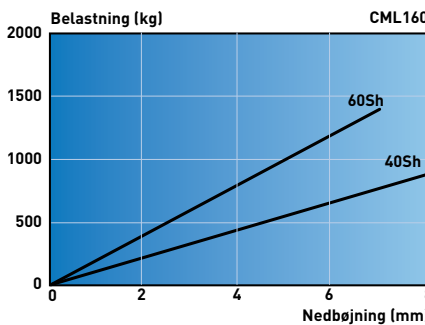
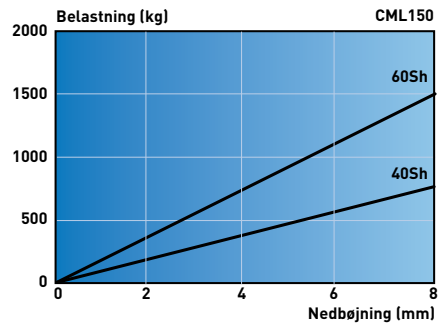
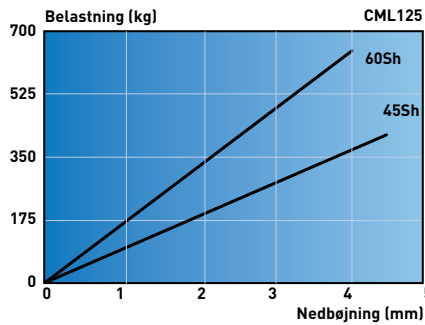
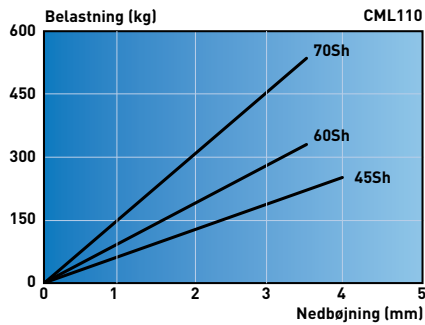
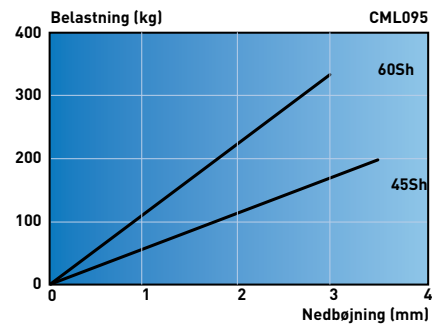
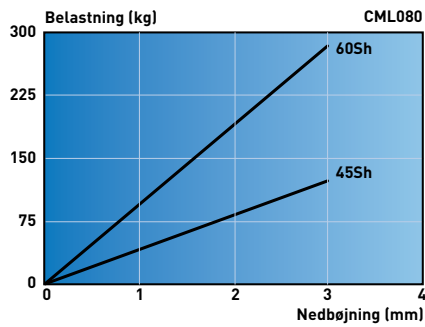
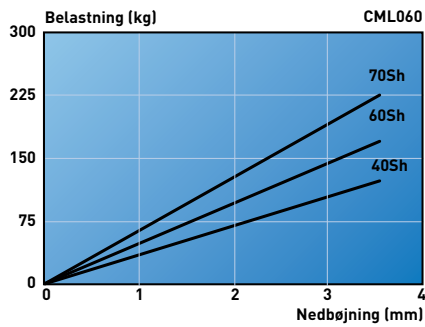

Type	40 Sh.		45 Sh.		60 Sh.		65 Sh.		70 Sh.	
	Maks Belastning (kg)	Nedbøjning (mm)	Maks Belastning (kg)	Nedbøjning (mm)	Maks Belastning (kg)	Nedbøjning (mm)	Maks Belastning (kg)	Nedbøjning (mm)	Maks Belastning (kg)	Nedbøjning (mm)
CML060	125	3.5	-	-	175	3.5	-	-	225	3.5
CML080	-	-	110	3.0	280	3.0	-	-	-	-
CML095	-	-	200	3.5	320	3.0	-	-	-	-
CML110	-	-	250	4.0	325	3.5	-	-	520	3.0
CML125	-	-	400	4.5	650	4.0	-	-	-	-
CML150	750	8.0	-	-	1500	8.0	-	-	-	-
CML160	900	8.0	-	-	1400	7.0	-	-	-	-
CML180	-	-	1250	8.0	2000	7.0	-	-	3000	5.5
CML220	-	-	2500	10.0	-	-	4000	9.0	5000	7.0